

# Richmond

I N T E R I O R S



Module  
Sofas  
2024







# Module sofas

Our modular sofa collection allows you to design your perfect seating arrangement, piece by piece. Whether you prefer a compact setup for cozy spaces or crave an expansive and luxurious lounging experience, our modular modules empower you to create the sofa of your dreams. Elevate your living space with personalized design, tailored to your taste, size, and comfort preferences.

Lund.....	4
Milton.....	5
Burton .....	6
Pasha .....	8
Felix .....	10
Devon.....	14
Santos .....	16
Fratelli .....	18
Fabric colors .....	22



# Lund module sofa (H x W x D)

## Sofa modules

The Lund sofa is super comfortable with wide armrests and comfy lumbar cushions. The sofa is available in modules, which creates the possibility to create various configurations to meet all your interior wishes.

## Maintenance

Keep the sofa away from direct sunlight. Plump up the cushion or pillow on a regular basis. Remove stains by dabbing, not rubbing. Note: normal use of the sofa makes the fabric more loose and the seats softer.

## Material

Seats: nosag springs, fiberfill, comfort foam.  
Back cushions: Foam flakes.

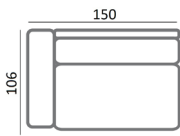

80 x 150 x 106 cm  
**S52302AL**

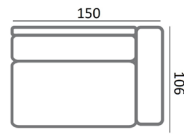

80 x 150 x 106 cm  
**S52302AR**

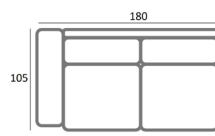

80 x 180 x 106 cm  
**S52302,5AL**

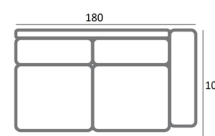

80 x 180 x 106 cm  
**S52302,5AR**

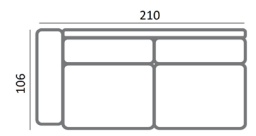

80 x 210 x 106 cm  
**S52303AL**

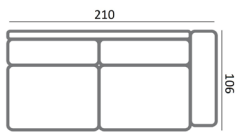

80 x 210 x 106 cm  
**S52303AR**

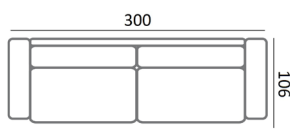

80 x 300 x 106 cm  
**S52304**

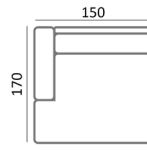

80 x 150 x 170 cm  
**S5230LCHAL**

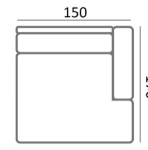

80 x 150 x 170 cm  
**S5230LCHAR**

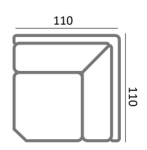

80 x 110 x 110 cm  
**S5230CORNER**

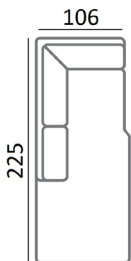

80 x 106 x 225 cm  
**S52300TML**

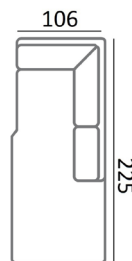

80 x 106 x 225 cm  
**S52300TMR**

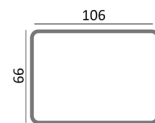

42 x 106 x 66 cm  
**S5230P106X66**

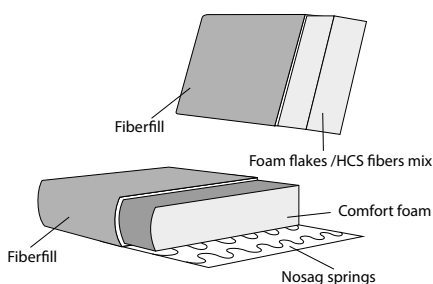

See page 22 for all available fabrics.



# (H x W x D) Milton module sofa

## Sofa modules

Milton is a elegant sofa without loose cushions making it relatively maintenance free. By choosing the right modules you can create a sofa to suit your wishes. For example, an outer corner to create a U-shaped sofa.

## Maintenance

Keep the sofa away from direct sunlight. Plump up the cushion or pillow on a regular basis. Remove stains by dabbing, not rubbing. Note: normal use of the sofa makes the fabric more loose and the seats softer.

## Material

Seats: nosag springs, comfort foam, upholstery.  
Back cushions: comfort foam.

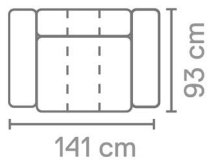

77 x 141 x 93 cm  
**S52401**

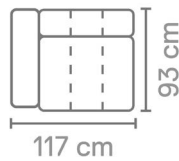

77 x 117 x 93 cm  
**S52401AL**

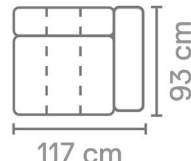

77 x 117 x 93 cm  
**S52401AR**

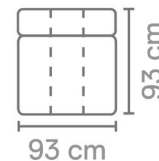

77 x 93 x 93 cm  
**S52401ZA**

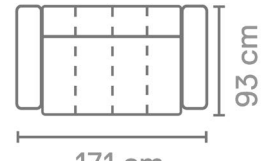

77 x 171 x 93 cm  
**S52402**

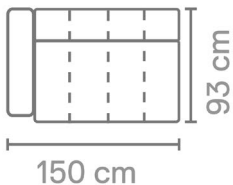

77 x 150 x 93 cm  
**S52402AL**

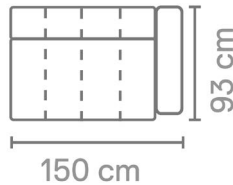

77 x 150 x 93 cm  
**S52402AR**

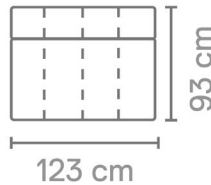

77 x 123 x 93 cm  
**S52402ZA**

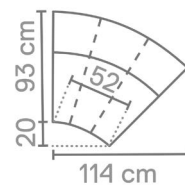

77 x 114 x 93 cm  
**S5240C45**

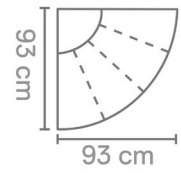

77 x 93 x 93 cm  
**S5240CO**

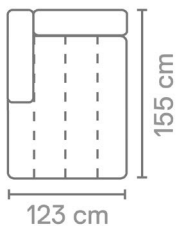

77 x 123 x 155 cm  
**S5240LCHL**

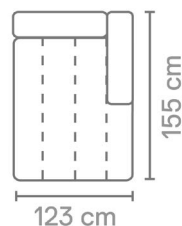

77 x 123 x 155 cm  
**S5240LCHR**

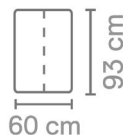

44 x 60 x 93 cm  
**S5240P60**

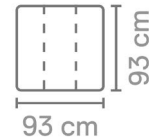

44 x 93 x 93 cm  
**S5240P93**

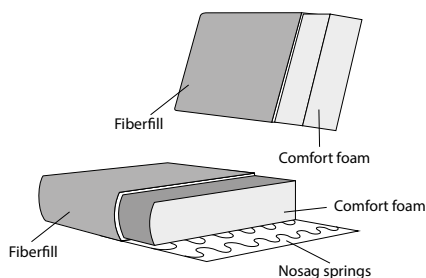

See page 22 for all available fabrics.

# Burton module sofa (H x W x D)

## Sofa modules

Burton is a very comfortable sofa which is characterized by the round corner and the comfy cushions. It is available in modules so you can create a sofa to suit your wishes.

## Maintenance

Keep the sofa away from direct sunlight. Plump up the cushion or pillow on a regular basis. Remove stains by dabbing, not rubbing. Note: normal use of the sofa makes the fabric more loose and the seats softer.

## Material

Seats: springs, soft foam, feather and chopped foam mix, upholstery.

Back cushions: feather and chopped foam mix, upholstery.

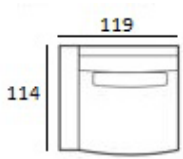

85 x 119 x 114 cm  
**BURTON-1,5AL**

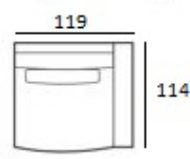

85 x 119 x 114 cm  
**BURTON-1,5AR**

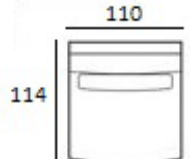

85 x 110 x 114 cm  
**BURTON-1,5XLZA**

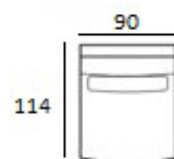

85 x 90 x 114 cm  
**BURTON-1,5ZA**



85 x 238 x 114 cm  
**BURTON-3**

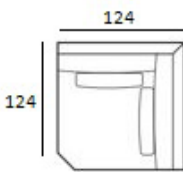

85 x 124 x 124 cm  
**BURTON-CORNERXL**

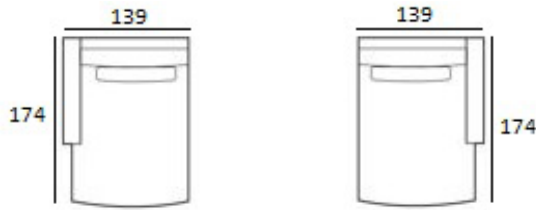

85 x 139 x 174 cm  
**BURTON-LCHLXL**

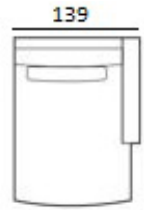

85 x 139 x 174 cm  
**BURTON-LCHRXL**



85 x 114 x 135 cm  
**BURTON-OTML**

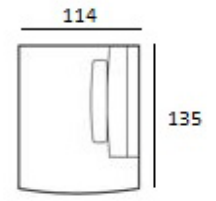

85 x 114 x 135 cm  
**BURTON-OTMR**

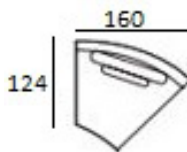

85 x 160 x 124 cm  
**BURTON-CORNERROUND**

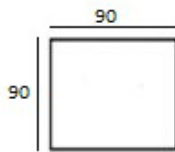

42 x 90 x 90 cm  
**BURTON-P90X90**

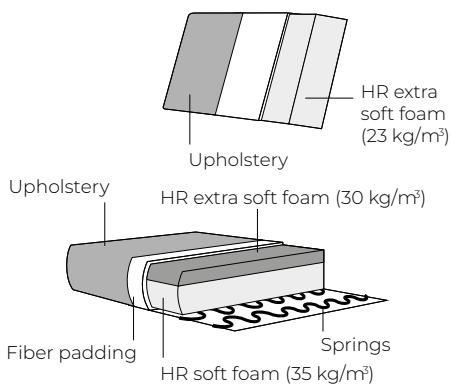

See page 22 for all available fabrics.











# (H x W x D) Pasha module sofa

## Sofa modules

Pasha is a spacious, super comfortable sofa with wide arm rests and an armrest over the full length of the lounge module. As the modules are completely upholstered they can even be placed as stand alone.

## Maintenance

Keep the sofa away from direct sunlight. Plump up the cushion or pillow on a regular basis. Remove stains by dabbing, not rubbing. Note: normal use of the sofa makes the fabric more loose and the seats softer.

## Material

Seats: springs, cold foam, upholstery.  
Back cushions: ballfiber and chopped foam mix, upholstery.

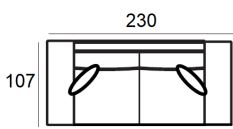

93 x 230 x 107 cm  
**S52102**

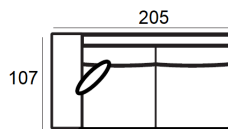

93 x 205 x 107 cm  
**S52102AL**

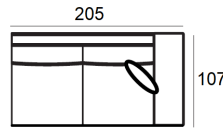

93 x 205 x 107 cm  
**S52102AR**

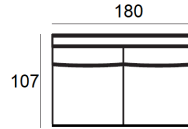

93 x 180 x 107 cm  
**S52102ZA**

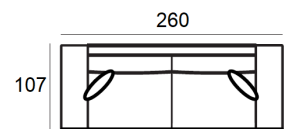

93 x 260 x 107 cm  
**S52103**

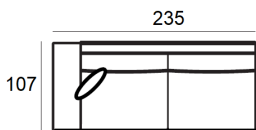

93 x 235 x 107 cm  
**S52103AL**

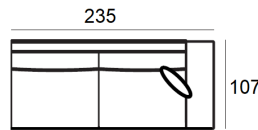

93 x 235 x 107 cm  
**S52103AR**

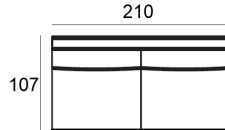

93 x 210 x 107 cm  
**S52103ZA**

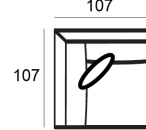

93 x 107 x 107 cm  
**S5210CORNER**

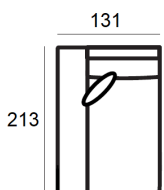

93 x 131 x 213 cm  
**S5210LCHL**

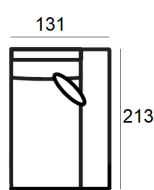

93 x 131 x 213 cm  
**S5210LCHR**

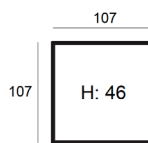

46 x 107 x 107 cm  
**S5210P107**



41 x 104 x 45 cm  
**6524 BLACK**

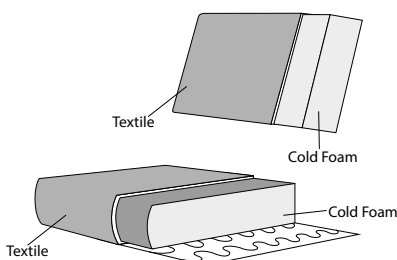

See page 22 for all available fabrics.

# Felix module sofa (H x W x D)

## Sofa modules

Felix is one of our most comfortable sofas and is characterized by the round loungepart, wide armrests and lumbar cushions. It is available in modules so you can create a sofa to suit your wishes.

## Maintenance

Keep the sofa away from direct sunlight. Plump up the cushion or pillow on a regular basis. Remove stains by dabbing, not rubbing. Note: normal use of the sofa makes the fabric more loose and the seats softer.

## Material

Seats: springs, HR soft foam 35 kg/m<sup>3</sup>, HR extra soft foam 30kg/m<sup>3</sup> fiber padding, upholstery.  
 Back cushions: HR extra soft foam 23kg/m<sup>3</sup>, upholstery.  
 Deco cushion: ballfiber, feather and chopped foam mix, upholstery.

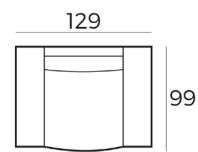

89 x 129 x 99 cm  
**FELIX-1**

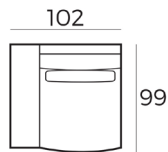

88 x 102 x 99 cm  
**FELIX-1AL**

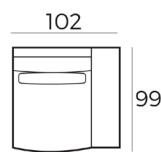

88 x 102 x 99 cm  
**FELIX-1AR**

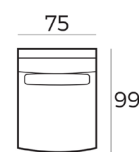

88 x 75 x 99 cm  
**FELIX-1ZA**

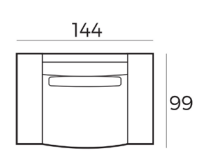

88 x 144 x 99 cm  
**FELIX-1,5**

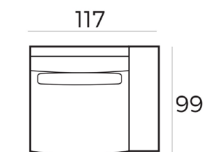

88 x 117 x 99 cm  
**FELIX-1,5AL**

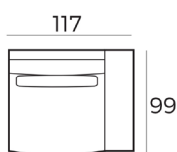

88 x 117 x 99 cm  
**FELIX-1,5AR**

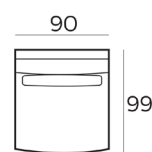

88 x 90 x 99 cm  
**FELIX-1,5ZA**

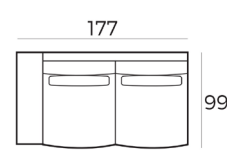

88 x 177 x 99 cm  
**FELIX-2,5AL**

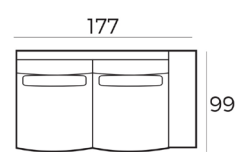

88 x 177 x 99 cm  
**FELIX-2,5AR**

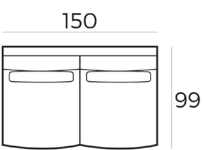

88 x 150 x 99 cm  
**FELIX-2,5ZA**

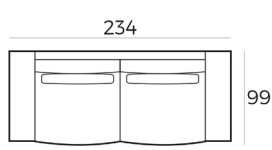

88 x 234 x 99 cm  
**FELIX-3**

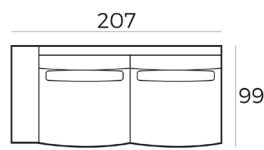

88 x 207 x 99 cm  
**FELIX-3AL**

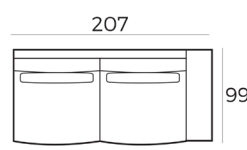

88 x 207 x 99 cm  
**FELIX-3AR**

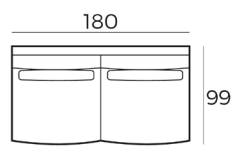

88 x 180 x 99 cm  
**FELIX-3ZA**

combine to your wishes  
with the many  
different modules

See page 22 for all available fabrics.

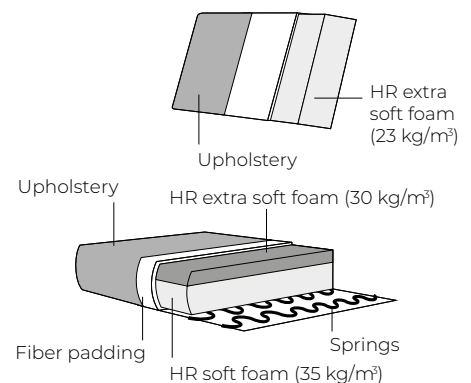



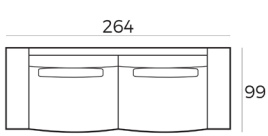

88 x 264 x 99 cm  
**FELIX-3,5**

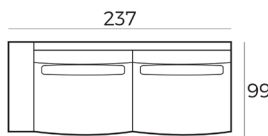

88 x 237 x 99 cm  
**FELIX-3,5AL**

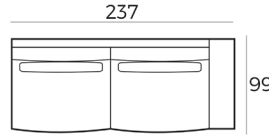

88 x 237 x 99 cm  
**FELIX-3,5AR**

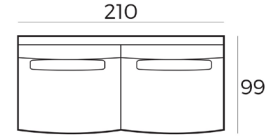

88 x 210 x 99 cm  
**FELIX-3,5ZA**

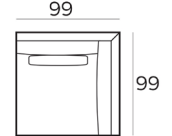

88 x 99 x 99 cm  
**FELIX-CORNER**

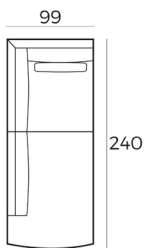

88 x 99 x 240 cm  
**FELIX-OTML**

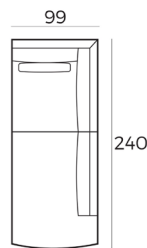

88 x 99 x 240 cm  
**FELIX-OTMR**

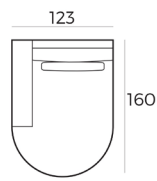

88 x 123 x 160 cm  
**FELIX-LCHRL**

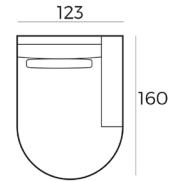

88 x 123 x 160 cm  
**FELIX-LCHRR**

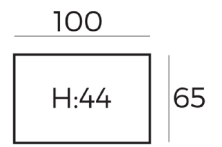

44 x 65 x 100 cm  
**FELIX-P65X100**

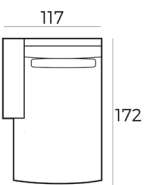

88 x 117 x 172 cm  
**FELIX-LCH90L**

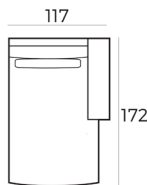

88 x 117 x 172 cm  
**FELIX-LCH90R**

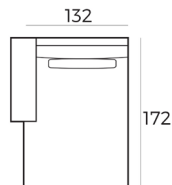

88 x 132 x 172 cm  
**FELIX-LCH105L**

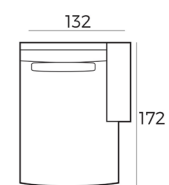

88 x 132 x 172 cm  
**FELIX-LCH105R**

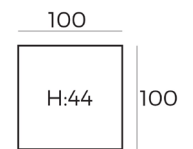

44 x 100 x 100 cm  
**FELIX-P100X100**















# (H x W x D) Devon module sofa

## Sofa modules

Devon is a stylish sofa without loose cushions making it relatively maintenance free. By choosing the right modules you can create the sofa to your liking. The modules are completely upholstered so they can even be placed as stand alone.

## Maintenance

Keep the sofa away from direct sunlight. Plump up the cushion or pillow on a regular basis. Remove stains by dabbing, not rubbing. Note: normal use of the sofa makes the fabric more loose and the seats softer.

## Material

Seats: cold foam, soft cold foam, fiber padding, upholstery.

Back cushions: cold foam, fiber padding, upholstery.

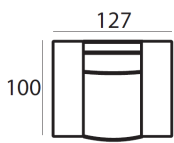

75 x 127 x 100 cm  
**DEVON-1**

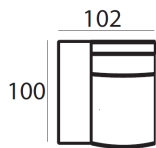

75 x 102 x 100 cm  
**DEVON-1AL**

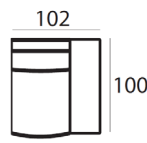

75 x 102 x 100 cm  
**DEVON-1AR**

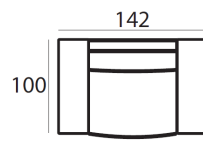

75 x 142 x 100 cm  
**DEVON-1,5**

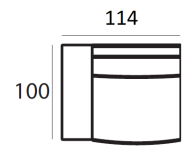

75 x 114 x 100 cm  
**DEVON-1,5AL**

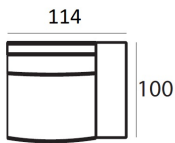

75 x 114 x 100 cm  
**DEVON-1,5AR**

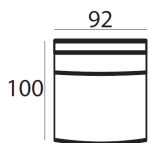

75 x 92 x 100 cm  
**DEVON-1,5ZA**

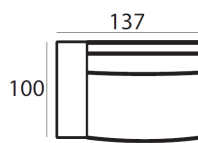

75 x 137 x 100 cm  
**DEVON-2AL**

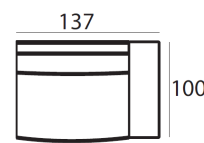

75 x 137 x 100 cm  
**DEVON-2AR**

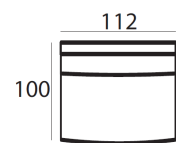

75 x 112 x 100 cm  
**DEVON-2ZA**

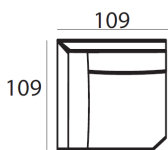

75 x 109 x 109 cm  
**DEVON-CORNER**

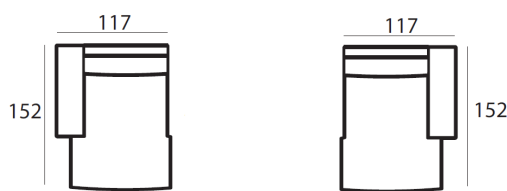

75 x 117 x 152 cm  
**DEVON-LCHL**

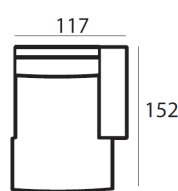

75 x 117 x 152 cm  
**DEVON-LCHR**

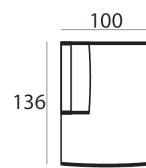

75 x 100 x 136 cm  
**DEVON-OTMOL**

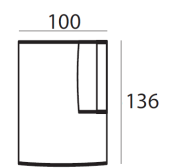

75 x 100 x 136 cm  
**DEVON-OTMOR**

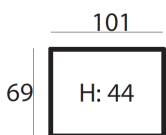

44 x 69 x 101 cm  
**DEVON-P69X101**

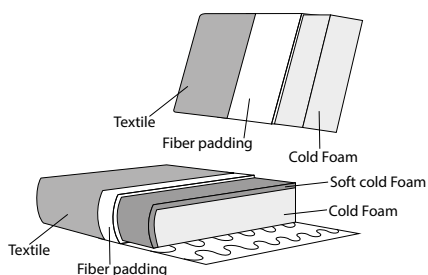

See page 22 for all available fabrics.



# Santos module sofa (H x W x D)

## Sofa modules

The Santos module sofa has a contemporary and stylish design with a luxurious seat. Create your ultimate setup with the various modules Santos has to offer.

## Maintenance

Keep the sofa away from direct sunlight. Plump up the cushion or pillow on a regular basis. Remove stains by dabbing, not rubbing. Note: normal use of the sofa makes the fabric more loose and the seats softer.

## Material

Seats: cold foam, chopped foam, fiber padding, upholstery.

Back cushions: ballfiber and chopped foam mix, upholstery.

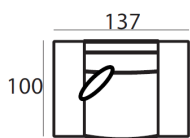

89 x 137 x 100 cm  
**SANTOS-1,5**

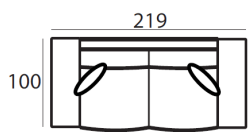

89 x 219 x 100 cm  
**SANTOS-2,5**

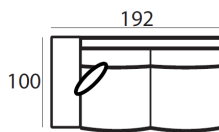

89 x 192 x 100 cm  
**SANTOS-2,5AL**

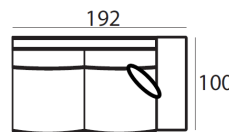

89 x 192 x 100 cm  
**SANTOS-2,5AR**

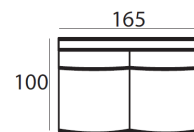

89 x 165 x 100 cm  
**SANTOS-2,5ZA**

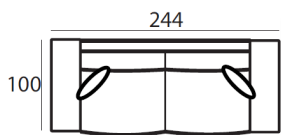

89 x 244 x 100 cm  
**SANTOS-3**

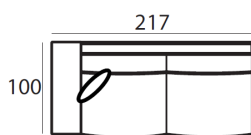

89 x 217 x 100 cm  
**SANTOS-3AL**

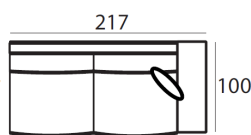

89 x 217 x 100 cm  
**SANTOS-3AR**

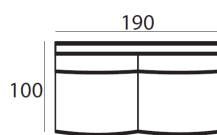

89 x 190 x 100 cm  
**SANTOS-3ZA**

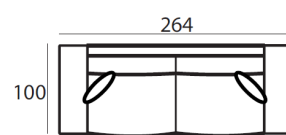

89 x 264 x 100 cm  
**SANTOS-3,5**

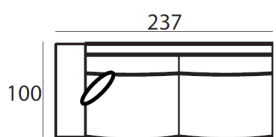

89 x 237 x 100 cm  
**SANTOS-3,5AL**

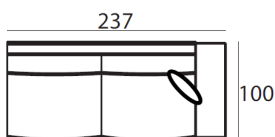

89 x 237 x 100 cm  
**SANTOS-3,5AR**

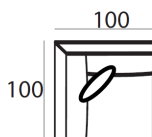

89 x 100 x 100 cm  
**SANTOS-CORNER**

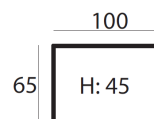

45 x 65 x 100 cm  
**SANTOS-P65X100**

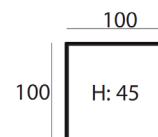

45 x 100 x 100 cm  
**SANTOS-P100X100**

combine to your wishes  
with the many  
different modules

See page 22 for all available fabrics.

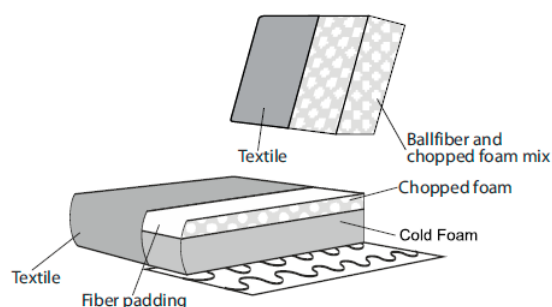

Upholstered furniture is handmade using soft materials therefore measurements may vary up to +/- 5 cm.

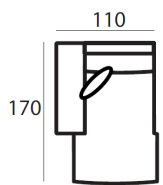

89 x 110 x 170 cm  
**SANTOS-LCH82,5L**

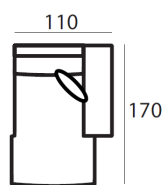

89 x 110 x 170 cm  
**SANTOS-LCH82,5R**

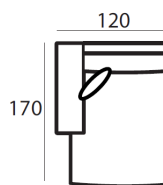

89 x 120 x 170 cm  
**SANTOS-LCH95L**

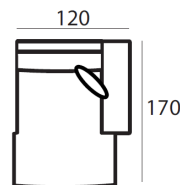

89 x 120 x 170 cm  
**SANTOS-LCH95R**

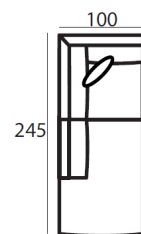

89 x 100 x 245 cm  
**SANTOS-OTML**

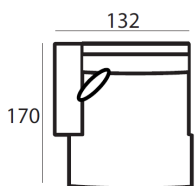

89 x 132 x 170 cm  
**SANTOS-LCH105L**

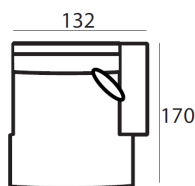

89 x 132 x 170 cm  
**SANTOS-LCH105R**

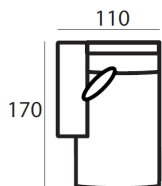

89 x 110 x 170 cm  
**SANTOS-LCH110L**

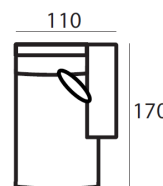

89 x 110 x 170 cm  
**SANTOS-LCH110R**

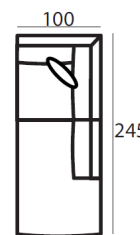

89 x 100 x 245 cm  
**SANTOS-OTMR**

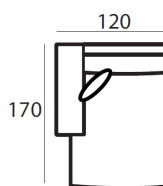

89 x 120 x 170 cm  
**SANTOS-LCH120L**

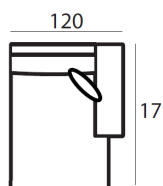

89 x 120 x 170 cm  
**SANTOS-LCH120R**

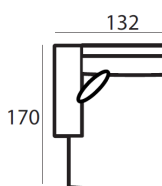

89 x 132 x 170 cm  
**SANTOS-LCH132L**

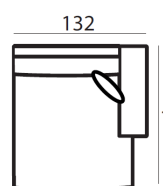

89 x 132 x 170 cm  
**SANTOS-LCH132R**



50 x 50 cm  
**SANTOS-PILLOW**



# Fratelli module sofa (H x W x D)

## Sofa modules

The Fratelli sofas are characterized by a sleek, clean appearance. The sofa is available in modules, which creates the possibility to create various configurations to meet all your interior wishes.

## Maintenance

Keep the sofa away from direct sunlight. Plump up the cushion or pillow on a regular basis. Remove stains by dabbing, not rubbing. Note: normal use of the sofa makes the fabric more loose and the seats softer.

## Material

Seats: springs, HR soft foam, HR extra soft foam, fiber padding, upholstery.

Back cushions: HR soft foam, fiber padding, HR soft foam.

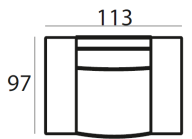

80 x 113 x 97 cm  
**FRATELLI-1**

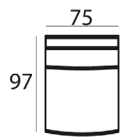

80 x 75 x 97 cm  
**FRATELLI-1ZA**

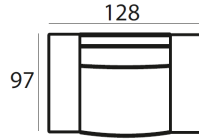

80 x 128 x 97 cm  
**FRATELLI-1,5**

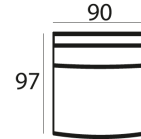

80 x 90 x 97 cm  
**FRATELLI-1,5ZA**

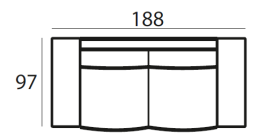

80 x 188 x 97 cm  
**FRATELLI-2,5**

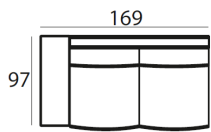

80 x 169 x 97 cm  
**FRATELLI-2,5AL**

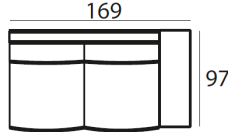

80 x 169 x 97 cm  
**FRATELLI-2,5AR**

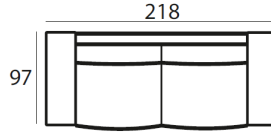

80 x 218 x 97 cm  
**FRATELLI-3**

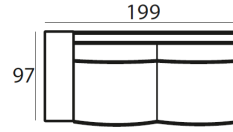

80 x 199 x 97 cm  
**FRATELLI-3AL**

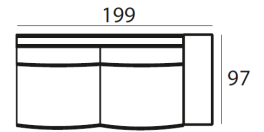

80 x 199 x 97 cm  
**FRATELLI-3AR**

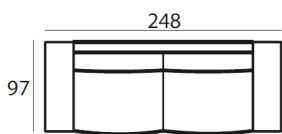

80 x 248 x 97 cm  
**FRATELLI-3XL**

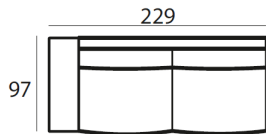

80 x 229 x 97 cm  
**FRATELLI-3XLAL**

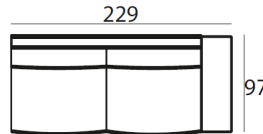

80 x 229 x 97 cm  
**FRATELLI-3XLAR**

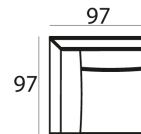

80 x 97 x 97 cm  
**FRATELLI-CORNER**

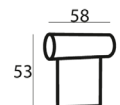

53 x 58 x 15 cm  
**FRATELLI-ROLL**

combine to your wishes  
with the many  
different modules

See page 22 for all available fabrics.

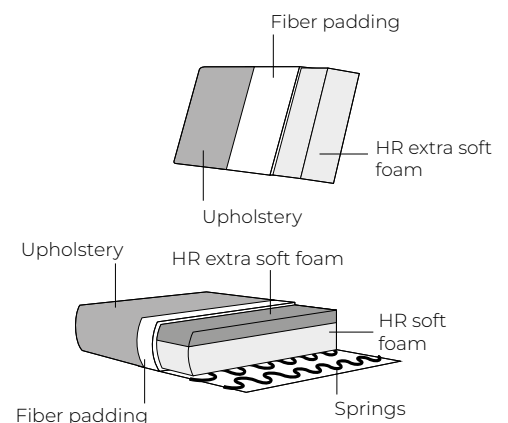



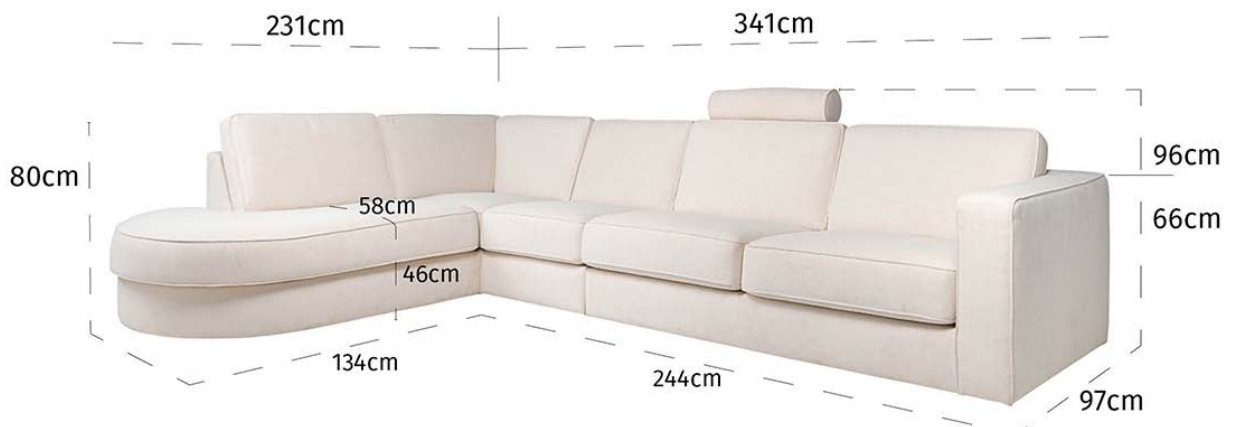
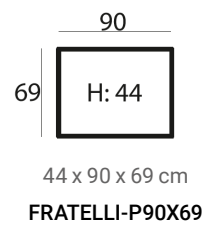
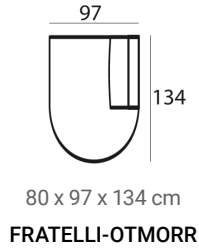
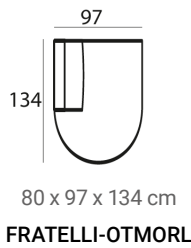
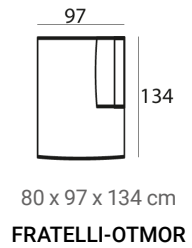
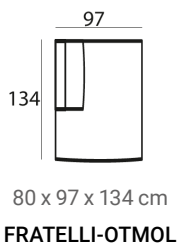
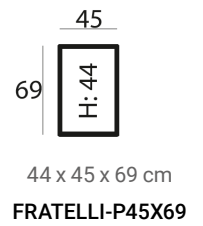
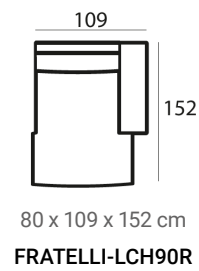
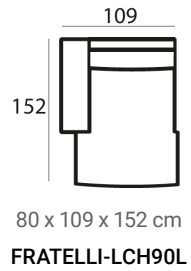
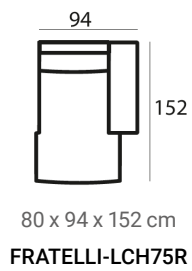
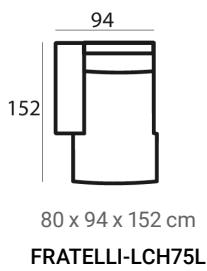









# Customize fabric colors

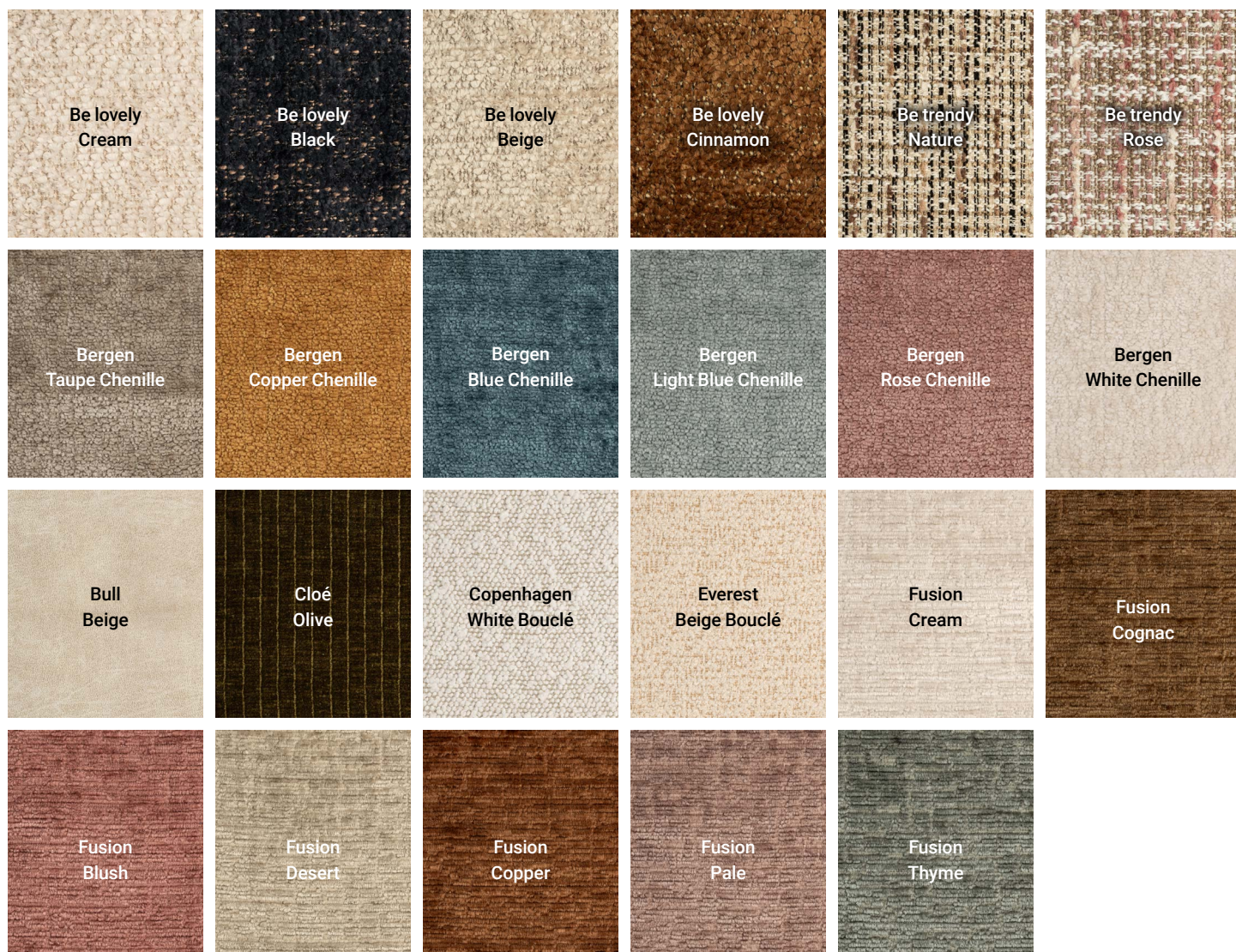

Fabric	Description	Composition faceside	Martindale	Pilling	Colour Fastness
Be lovely	Be Lovely is a very soft and fluffy fabric with a trendy look. The finely coordinated colors add the finishing touch to the extremely soft feel. Thanks to its soft feel, the fabric looks very luxurious	100% PES	>45.000	4-5	6
Be trendy	A real eye-catcher - the fabric Be Trendy is a woven article that elegantly combines Melounge yarns with chenille yarns. Absolutely TRENDY.	100% PES	60.000	4	6
Bergen	Bergen, a landscape of intricating heavy chenille. This rich upholstery fabric has a soft touch.	100% PES	100.000	5	5
Bull	The unique characteristic of this article is the "leather aspect" together with the pleasant handfeel of fabric. The backing of Bull exists out of 100% recycled leather fibres. Leather leftovers are ground by a shredder and after a special process flocked on a knitted microfiber. This unique leather fibre backing creates this special, comfortable and thick grip. The top layer is a knitted microsuede with a leather print and an embossing.	100% PES	32.000	3-4	3-4
Cloé	Cloe is a classic and stylish cord-velour that stands out with its stunning feel. This beautiful chenille jacquard makes any piece of furniture look trendy.	100% PES	48.000	5	5
	Copenhagen is a trendy bouclé fabric. This bouclé fabric has a looped appearance and knotted surface that ensures a natural look and ultimate soft touch.	100% PES	100.000	5	5
Everest	Everest is a bouclé fabric with a subtle two-tone effect. Made with 100% recycled polyester yarns.	100% PES	80.000	4-5	4-5
Fusion	Fusion offers a heavy and chunky quality while the chenille yarns create an elegant, soft and full hand feel. The dessin is subtle and can be styled both as an interior basis or accent fabric.	100% PES	85.000	4-5	5



# Customize fabric colors



Fabric	Description	Composition faceside	Martindale	Pilling	Colour Fastness
Giulia	Giulia is woven from a blend of yarns and stands out with its distinctive noble appearance. The stylish impression convinces with its beautiful, natural look, especially with its rich character and soft touch.	85% PES, 15%VI	>85.000	5	4-5
Island	Island is a fabric that will lift the appearance of any furniture item on its own. The dessin shines slightly and is luxurious with the use of heavy chenille yarns, therefore it can be styled both as an interior basis or accent fabric.	100% PES	55.000	5	4-5
Jasper	The contemporary interpretation of the ribbed, velvet-like fabric. The extraordinary retro wave is interrupted by an exciting stiffness. The exciting image of the yarn-dyed chenille fabric is supported by a melange effect.	100% PES	>35.000	4-5	5
Miami	A nice, elegant and soft quality with voluminous grip. Chenille fabrics, such as Miami, are perfect for creating cozy, warm and elegant furniture. Kindly note that during use a sitting mirror/ seat depression will appear, this can be minimized by brushing Miami on a regular base. Important is to mention that this can never be taken away completely.	70% PES, 30%VI	85.000	4	4-5
Niagara	Niagara is a soft and lofty chenille fabric. It's made of 100% PES and has no backing, making it very drapable.	100% PES	100.000	4	5-6
Quartz	Quartz is a knitted velvet which is named after the gemstone because of its exquisite qualities. With its very fine high pile, matt look and extreme softness, this fabric is usable in many different applications.	100% PES	45.000	4-5	4-5
Sheep	Sheep is a fluffy fabric with a trendy look. The finely coordinated colors add the finishing touch to the extremely soft feel. Sheep is made of pure polyester, which makes it particularly durable.	100% PES	> 35.000	4-5	6
Unicorn	Unicorn is a trendy structural fabric with a discreet two-colored finish. Unicorn also appeals by an extremely soft feel, which is created using chenille yarn. Unicorn is breathable, with a surface structure that looks fresh and trendy.	100% PES	> 35.000	4-5	6



where luxury  
meets comfort

Richmond  
INTERIORS



Butter 17 · 1713 GM Obdam  
The Netherlands

Check our website for opening hours.  
Our showroom is open 6 days a week.

Follow us on  
[@richmondinteriors](#)



[RICHMONDINTERIORS.NL](http://RICHMONDINTERIORS.NL)